



Compact 3 Phase Voltage Monitor TVM Series The Net™ Motor Protector



US Patent 6541954
ANSI Device #27/47/59



- Protects Against: Phase Loss, Phase Reversal, Under, Over, and Unbalanced Voltages, Short Cycling
- Fixed Trip Points and Delays
- Fixed Voltages from 208 .. 480 V AC
- Isolated 10 A, SPDT Relay Contacts
- Bi-color LED Indicator Shows: Output Status, Faults, Time Delays and Phase Reversal
- ASME A17.1 rule 210.6
- NEMA MG1 14:30, 14:35
- IEEE C62.41-1991 Level B

Approvals:  

Description

Provides protection for motors and other sensitive loads. Continuously measures the voltage of each of the three phases using a new microcomputer circuit design that senses under and over voltage, voltage unbalance, phase loss, and phase reversal. Protection is provided even when regenerated voltages are present. Includes a trip delay to prevent nuisance tripping and a restart delay to prevent short cycling after a momentary power outage.

Operation

Upon application of line voltage, the restart delay begins. The output relay is de-energized during restart delay. Under normal conditions, the output energizes after restart delay. Undervoltage, overvoltage, and voltage unbalance must be sensed for continuous trip delay period before the output is de-energized. The output will not de-energize if a fault is corrected during the trip delay. The restart delay begins as soon as the output relay de-energizes. If the restart delay is completed when the fault is corrected, the output relay will energize immediately. The output relay will not energize if a fault or phase reversal is sensed as three phase input voltage is applied.

Reset: Reset is automatic upon correction of a fault.

LED Operation

The LED flashes green during the restart delay, then glows green when the output energizes. It flashes red during the trip delay then glows red when the output de-energizes. It flashes red/green if phase reversal is sensed.

LED Flashing Table

Trip Delay	Red	ON/OFF	115 FPM
Restart Delay	Green	ON/OFF	57 FPM
Phase Reversal	Red/Green	Alternate	115 FPM

FPM = Flashes per minute

Connection

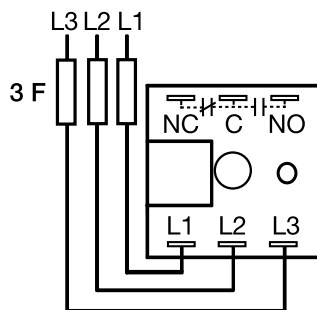

Relay contacts are isolated. Dashed lines are internal connections.

F = 2A Fast Acting Fuses are recommended, but not required.

L1 = Phase A L2 = Phase B L3 = Phase C
NO = Normally Open NC = Normally Closed
C = Common, Transfer Contact

Mechanical View

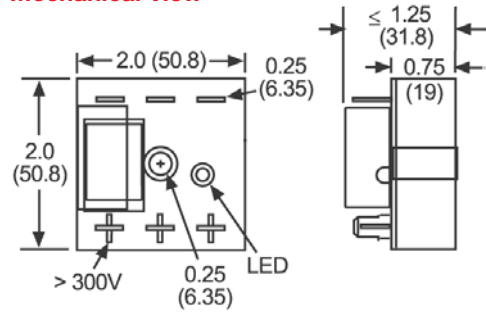

Inches (Millimeters)

Accessories



Female quick connect P/Ns:
P1015-13 (AWG 10/12)
P1015-64 (AWG 14/16)
P1015-14 (AWG 18/22)

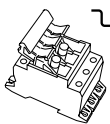

3-phase fuse block/disconnect
P/N: P0700-241
2 Amp Fuse
P/N: P0600-11

See accessory pages for specifications.

Ordering Table

TVM Series	X Line Voltage	X Voltage Unbalance	X Trip Delay	X Restart Delay
	208 A - 208 V AC	Specify Fixed Percentage 4, 5, 6, 7, 8, 9, or 10	Specify Fixed Delay In Seconds (S) [0.2 ... 1] In 0.1 s Increments [1 ... 100] In 1 s Increments	Specify Fixed Delay In Seconds (S) [0.4 ... 1] In 0.1 s Increments [1 ... 100] In 1 s Increments In Minutes (M) [1 ... 999] In 1 M Increments
	220 A - 220 V AC			
	230 A - 230 V AC			
	240 A - 240 V AC			
	380 A - 380 V AC			
	400 A - 400 V AC			
	415 A - 415 V AC			
	440 A - 440 V AC			
	460 A - 460 V AC			
	480 A - 480 V AC			

Example P/N: TVM240A45S10S

Compact 3 Phase Voltage Monitor TVM Series The Net™ Motor Protector

Voltage
Monitors

Technical Data

Line Voltage Type Input Voltage Line Frequency Phase Sequence Power Consumption	Three phase Delta or Wye with no connection to neutral 208 ... 480 V AC (See Ordering Table) 50 ... 100 Hz ABC Approx. 2 W for 240 V units Approx. 3 W for 480 V units
Overvoltage, Undervoltage, & Voltage Unbalance Overvoltage & Undervoltage Undervoltage Trip Point Reset Voltage Overvoltage Trip Point Reset Voltage Trip Variation vs Temperature Voltage Unbalance Reset On Balance Trip Delay Range Restart Delay Range	Voltage detection with delay trip & automatic reset 88 ... 92% of the selected line voltage $\pm 3\%$ of trip voltage 109 ... 113% of the selected line voltage $\pm 3\%$ of trip voltage $\leq \pm 2\%$ Factory fixed, from 4 ... 10% $\pm 0.7\%$ unbalance Fixed, from 0.2 ... 100 s, $\pm 15\%$ or ± 0.1 s, whichever is greater Fixed, from 0.4 s ... 999 m, $\pm 15\%$ or ± 0.1 s, whichever is greater
Phase Reversal & Phase Loss Response Phase Loss	≤ 200 ms; automatic reset $\geq 25\%$ unbalance
Output Type Rating	Isolated SPDT relay contacts 10 A resistive @ 125 V AC, 5 A @ 250 V AC, 1/4 hp @ 125 V AC 10 A resistive @ 240 V AC, 1/4 hp @ 125 V AC, 1/3 hp @ 250 V AC; max. voltage 277 V AC Mechanical-- 1×10^6 ; Electrical -- 1×10^5
Life	
Protection Surge Dielectric Breakdown	IEEE C62.41-1991 Level B ≥ 1500 V RMS input to output terminals ≥ 2500 V RMS input to output terminals
Mechanical Mounting Termination	Surface mount with one #8 (M5 x 0.8) screw 0.25 in. (6.35 mm) male quick connect terminals
Environmental Storage Temperature Humidity Weight	$-40^\circ\text{C} \dots +85^\circ\text{C}$ 95% relative, non-condensing ≈ 2.8 oz (79 g)

Operating Temperature

Line VAC	Output A/ Line V	Unmounted	On Metal Surface
208/240V	@1A, Nom.V	$-40^\circ\text{C} \dots +70^\circ\text{C}$	$+75^\circ\text{C}$
208/240V	@1A, +110%V	$-40^\circ\text{C} \dots +65^\circ\text{C}$	$+70^\circ\text{C}$
380/480V	@1A, Nom.V	$-40^\circ\text{C} \dots +65^\circ\text{C}$	$+70^\circ\text{C}$
380/480V	@1A, +110%V	$-40^\circ\text{C} \dots +60^\circ\text{C}$	$+65^\circ\text{C}$

7

Accessory

VRM Voltage Reduction Module

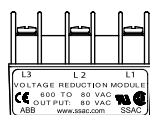

P/N: **VRM6048**

The VRM6048 Accessory Module allows the TVM9XXX to monitor a 3-Phase 550 ... 600 V AC Line.

Voltage:	INPUT	*OUTPUT
	600 V AC	480 V AC
	575 V AC	460 V AC
	550 V AC	440 V AC

Package: Molded Housing with Encapsulated Circuitry
 Mounting: Surface Mount with One #10 (M5 x 0.8) Plastic Screw. May be DIN Rail Mounted Using P1023-20 Adaptor
 Termination: Screw Terminals with Captive Wire Clamps for up to No.12 AWG Wire.

Connection

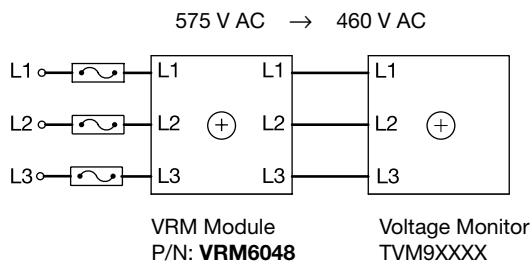

* The VRM6048 must be connected as shown. If the TVM9XXX is disconnected, the VRM output voltage equals the input voltage.

Adjustment: If the measured line voltage is 575 V AC, connect as shown and adjust the TVM9XXX for 460 V AC operation.

Operating: -40°C to $+70^\circ\text{C}$
 Storage: -40°C to $+85^\circ\text{C}$
 Humidity: 95% Relative, Non-Condensing

Mechanical View

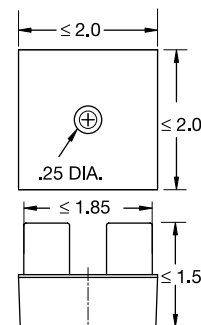

Inches (Millimeters)

TVM02E01 01.20.05