

Delay On Make (Operate)

TSD1 Digi-Timer

Timing Module

5

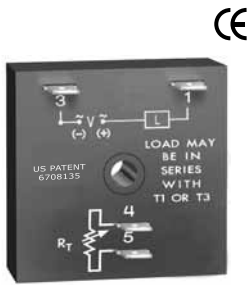

- Fixed or Adjustable Delays From 0.1 s ... 100 h
- +/-0.1% Repeat Accuracy
- +/-1% Factory Calibration
- 12 ... 230 V in 6 Ranges
- 1 A Solid State Output
- Encapsulated

Approvals:

Accessories

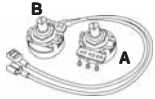

External adjust potentiometer
P/Ns:
P1004-95 (fig A)
P1004-95-X (fig B)



Mounting bracket
P/N: **P1023-6**



Female quick connect
P/N:
P1015-64 (AWG 14/16)

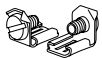

Quick connect to screw adaptor
P/N: **P1015-18**



Versa-knob
P/N: **P0700-7**

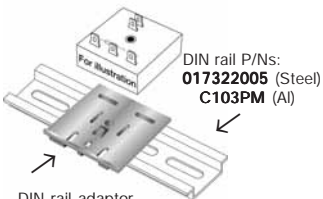

DIN rail adaptor
P/N: **P1023-20**

See accessory pages for specifications.

Description

The TSD Series is designed for more demanding commercial and industrial applications where small size, and accurate performance is required. The factory calibration for fixed time delays is within 1% of the target time delay. The repeat accuracy, under stable conditions, is 0.1% of the time delay. The TSD Series is rated to operate over an extended temperature range. Time delays of 0.1 seconds to 100 hours are available. The output is rated 1 A steady and 10 A inrush. The modules are totally solid state and encapsulated to protect the electronic circuitry.

Operation

Upon application of input voltage, the time delay begins. The output is de-energized before and during the time delay. At the end of the time delay, the output energizes and remains energized until input voltage is removed.

Reset: Removing input voltage resets the time delay and output.

Function

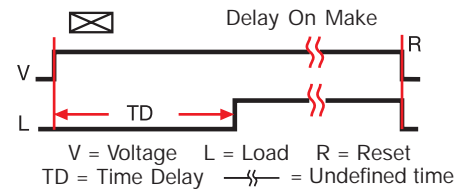

Connection

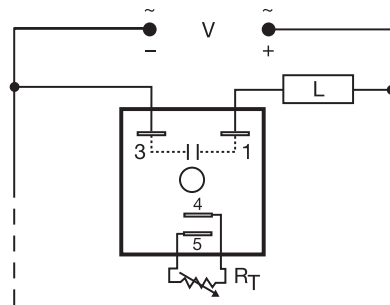

Load may be connected to terminal 3 or 1.
 R_T is used when external adjustment is ordered.
Dashed lines are internal connections.

Ordering Table

TSD1 Series

X Input

-1	- 12 V DC
-2	- 24 V AC
-3	- 24 V DC
-4	- 120 V AC
-5	- 120 V DC
-6	- 230 V AC

X Adjustment

-1	- Fixed
-2	- External Adjust
-3	- Onboard Adjust

X Time Delay*

-0	- 0.1 ... 10 s
-1	- 1 ... 100 s
-2	- 10 ... 1000 s
-3	- 0.1 ... 10 m
-4	- 1 ... 100 m
-5	- 10 ... 1000 m
-6	- 1 ... 100 h

Example P/N: **TSD1421** Fixed – **TSD1410.5S**

*If Fixed Delay is selected, insert delay [0.1 ... 1000] followed by (S) secs. or (M) mins., or [1 ... 100] (H) hours.

Delay On Make (Operate)

TSD1 Digi-Timer

Timing Module

Technical Data

Time Delay	
Range	0.1 s ... 100 h in 7 adjustable ranges or fixed
Repeat Accuracy	+/-0.1% or 20 ms, whichever is greater
Tolerance (Factory Calibration)	≤ +/-1%
Recycle Time	≤ 150 ms
Time Delay vs. Temperature & Voltage	≤ +/-1%
Input	
Voltage	12, 24, 120 V DC; 24, 120, 230 V AC
Tolerance	+/-20%
Line Frequency	50 ... 60 Hz
Output	
Type	Solid state
Form	Normally Open, open during timing
Maximum Load Current	1 A steady state, 10 A inrush at 60°C
Minimum Holding Current	≤ 40 mA
Off State Leakage Current	≅ 7 mA at 230 V AC
Voltage Drop	≅ 2.5 V at 1 A
Protection	
Circuitry	Encapsulated
Dielectric Breakdown	≥ 2000 V RMS terminals to mounting surface
Insulation Resistance	≥ 100 MΩ
Polarity	DC units are reverse polarity protected
Mechanical	
Mounting	Surface mount with one #10 (M5 x 0.8) screw
Package	2 x 2 x 1.21 in. (50.8 x 50.8 x 30.7 mm)
Termination	0.25 in. (6.35 mm) male quick connect terminals
Environmental	
Operating Temperature	-40°C ... +75°C
Storage Temperature	-40°C ... +85°C
Humidity	95% relative, non-condensing
Weight	≅ 2.4 oz (68 g)

External Resistance vs Time Delay

In Secs., Mins., or Hours

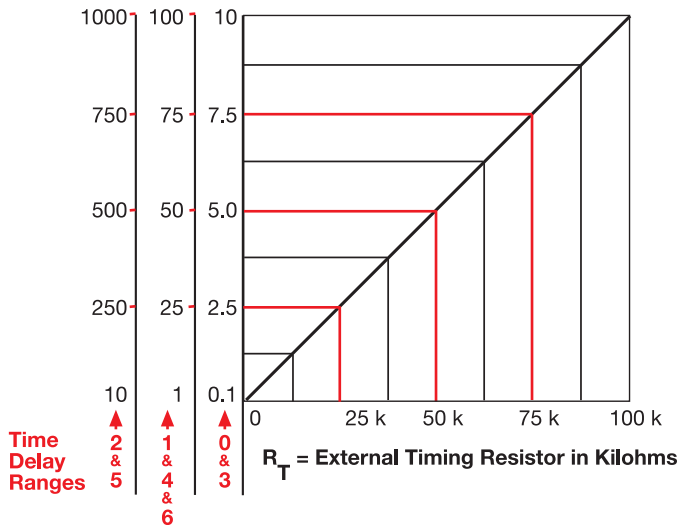

This chart applies to externally adjustable part numbers.

The time delay is adjustable over the time delay range selected by varying the resistance across the R_T terminals; as the resistance increases the time delay increases.

When selecting an external R_T , add the tolerances of the timer and the R_T for the full time range adjustment.

Examples: 1 to 50 S adjustable time delay, select time delay range 1 and a 50 K ohm R_T . For 1 to 100 S use a 100 K ohm R_T .

Mechanical View

Fixed & External Adjust

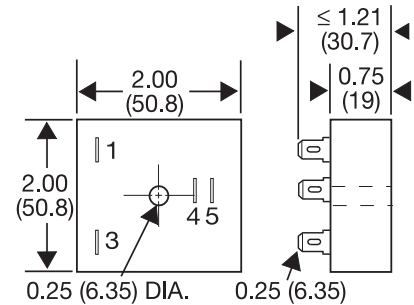

Onboard Adjust

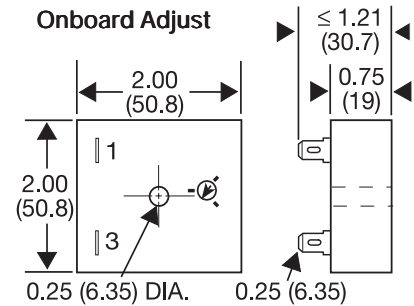

Inches (Millimeters)